

FEATURES

- * 0.3 inch (7.62 mm) DIGIT HEIGHT
- * EXCELLENT SEGMENT UNIFORMITY
- * LOW POWER REQUIREMENT
- * HIGH BRIGHTNESS AND HIGH CONTRAST
- * WIDE VIEWING ANGLE
- * SOLID STATE RELIABILITY
- * BINNED FOR LUMINOUS INTENSITY

DESCRIPTION

The LSHD-7801 is a 0.3 inch (7.62 mm) digit height single-digit display. This device uses GREEN LED chips (GaP epi on GaP substrate). The display has gray face and green segments.

DEVICE

PART NO.	DESCRIPTION
GREEN	Common Anode
LSHD-7801	Rt. Hand Decimal

PACKAGE DIMENSIONS

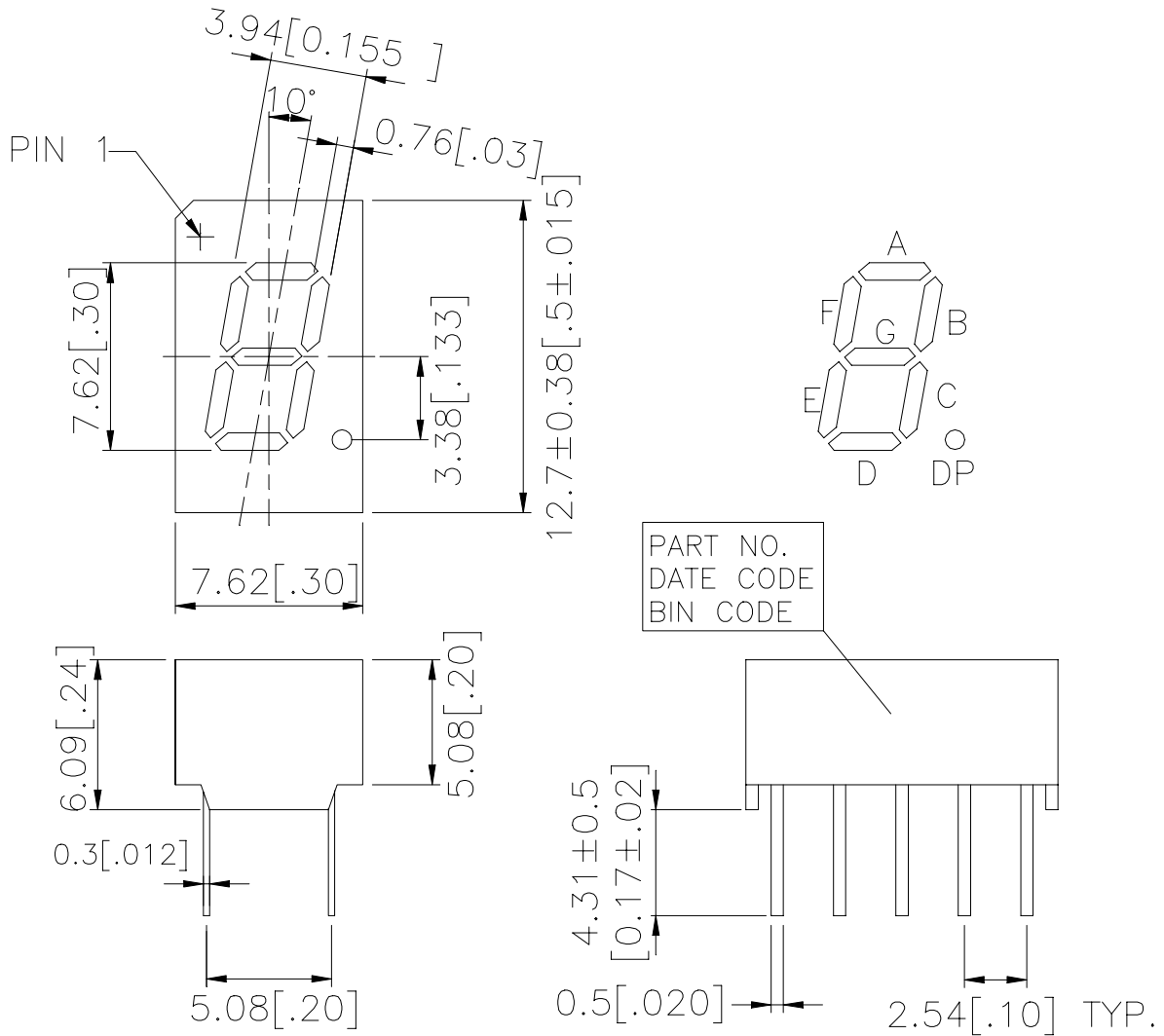

NOTES: All dimensions are in millimeters. Tolerances are ± 0.25mm (0.01") unless otherwise noted.

INTERNAL CIRCUIT DIAGRAM

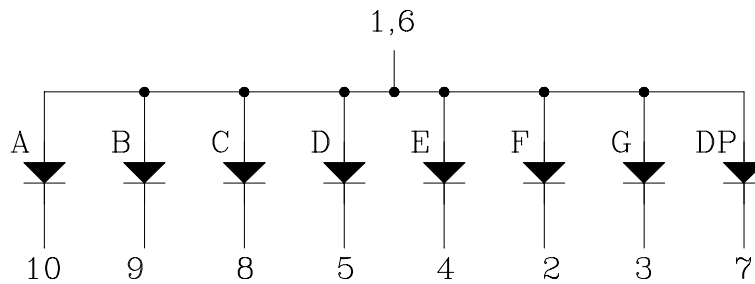

PIN CONNECTION

No.	CONNECTION
1	Common Anode
2	Cathode F
3	Cathode G
4	Cathode E
5	Cathode D
6	Common Anode
7	Cathode DP
8	Cathode C
9	Cathode B
10	Cathode A

ABSOLUTE MAXIMUM RATING AT Ta = 25°C

PARAMETER	MAXIMUM RATING	UNIT
Power Dissipation Per Segment	75	mW
Peak Forward Current Per Segment (Frequency 1Khz, 10% duty cycle)	100*	mA
Continuous Forward Current Per Segment	25	mA
Forward Current Derating from 25°C	0.28	mA/°C
Reverse Voltage Per Segment	5	V
Operating Temperature Range	-35°C to +105°C	
Storage Temperature Range	-35°C to +105°C	
Soldering Conditions : 1/16 inch below seating plane for 3 seconds at 260°C		

* see figure 5 to establish pulsed condition

ELECTRICAL / OPTICAL CHARACTERISTICS AT Ta = 25°C

PARAMETER	SYMBOL	MIN	TYP	MAX	UNIT	TEST CONDITION
Average Luminous Intensity Per Segment	I _v	500	1600		μcd	I _F = 10mA
Peak Emission Wavelength	λ _p		565		nm	I _F = 20mA
Spectral Line Half-Width	Δλ		30		nm	I _F = 20mA
Dominant Wavelength	λ _d		569		nm	I _F = 20mA
Forward Voltage Per Segment	V _F		2.1	2.6	V	I _F = 20mA
Reverse Current Per Segment	I _R			100	μA	V _R = 5V
Luminous Intensity Matching Ratio	I _v -m			2 : 1		I _F = 10mA

Note: Luminous Intensity is measured with a light sensor and filter combination that approximates the CIE (Commision Internationale De L'Eclairage) eye-response curve.

TYPICAL ELECTRICAL / OPTICAL CHARACTERISTIC CURVES

(25°C Ambient Temperature Unless Otherwise Noted)

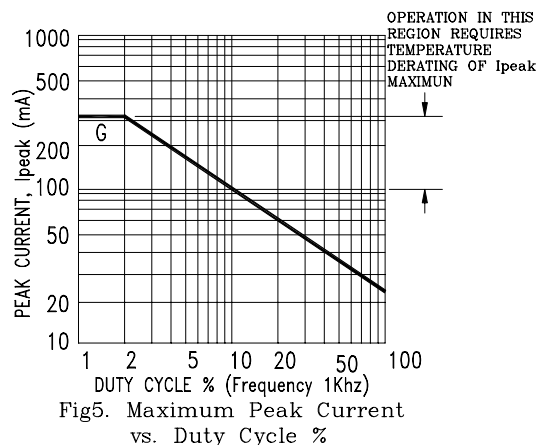
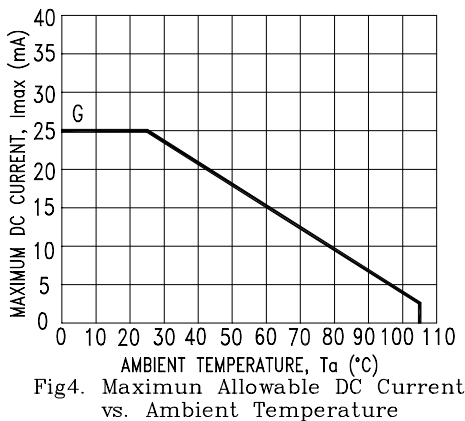
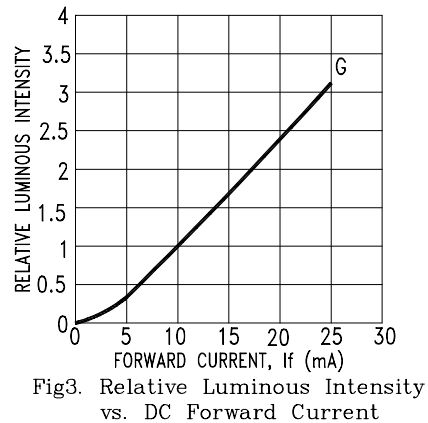
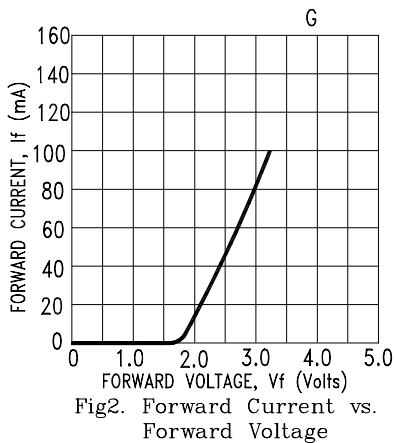
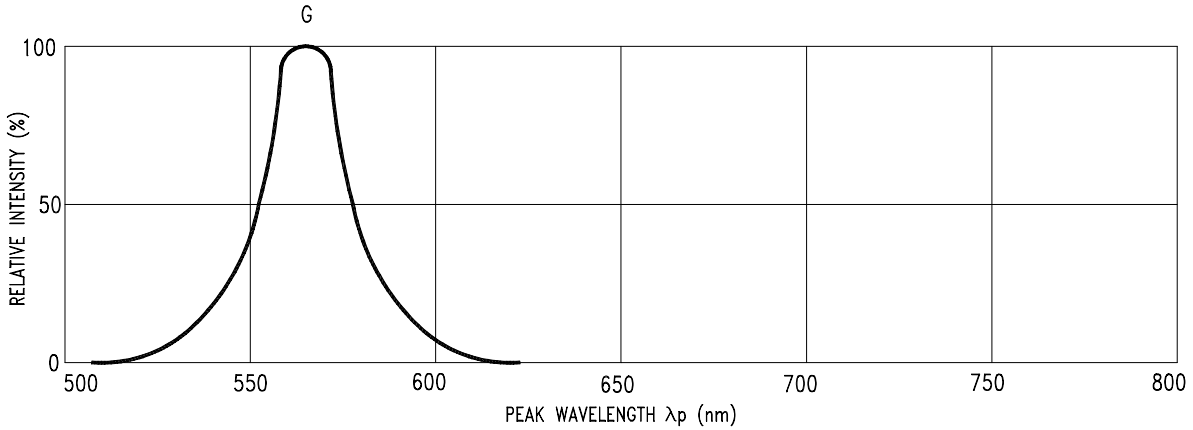

NOTE: G=GREEN.